



Clip-in Ceiling System
夹入式天花板系统



Clip-in Ceiling System

夹入式天花板系统



Aluminum Ceiling Panel Specification Sheet







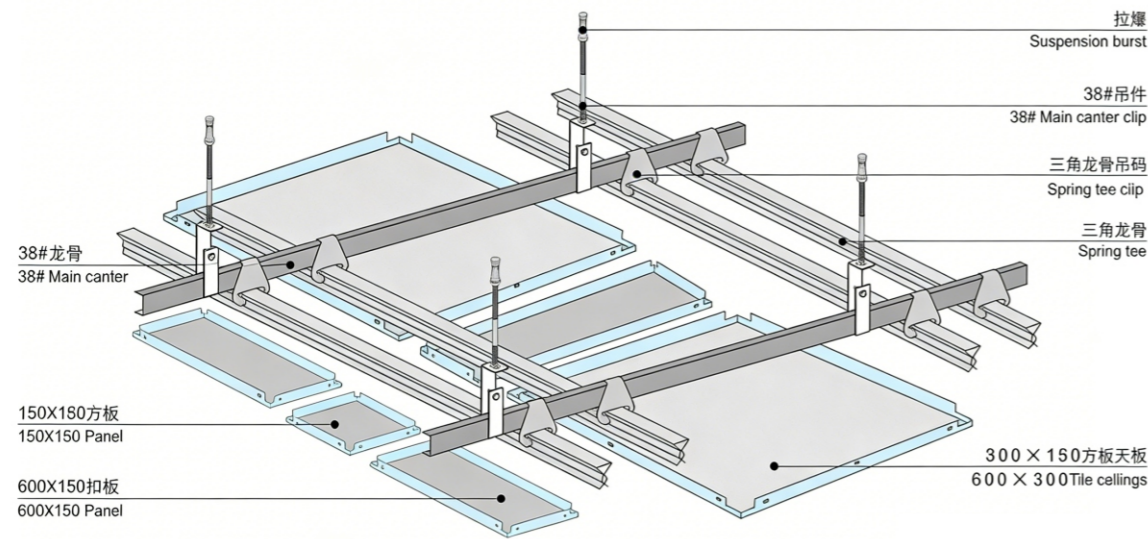

(W×H)mm	300X300 400X400 500X500 600X300 600X600 800X800 1200X300 1200X600
Aluminum baffle ceiling Thickness	0.5–0.9 mm

INSTALLATION DIAGRAM

安装示意图



System Accessories / 系统配件

	
#38 Main Keel	screw rod
	
Triangle Carrier	Spring Tee Hanging Clip
	
#38 Main Keel Hanging Clip	nut
	
pop rivet head	corner bead



Product Display Image

产品展示图

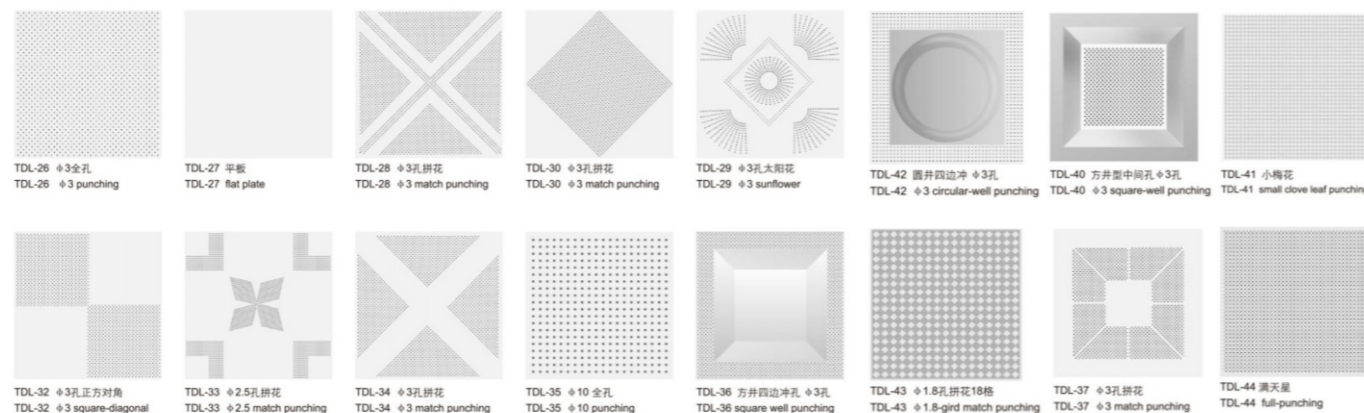

Applications Ceiling Decoration

天花板装饰应用

Commercial Buildings, Airports, High-speed trains/Stations, Subways, Sports venues, Storefront Signs, 4S Stores/Sales Departments Show Rooms, Cafe Zone, Corridor, Schools, Parks, Meeting Rooms, Villas, Office Buildings, Hospitals, Administrative Passages, Showrooms, Bus Termination, Waiting-Room, Living-Room, Supermarket, Buildings, Exhibition Halls, Tunnels, Homes, Opera Houses, Hotels/clubs, Banks, Basements, Parking Lots, Farms, Overpasses/Sidewalks, Toll Stations, Gas Stations, Factories/Workshops, Shopping Malls/Restaurants, Libraries, Computer Rooms, etc

商业建筑、机场、高速列车/车站、地铁、体育场馆、店面招牌、4S商店/销售部门展示厅、咖啡厅区、走廊、学校、公园、会议室、别墅、办公楼、医院、行政通道、展示厅、公交停靠站、候车室、起居室、超市、楼宇、展览厅、隧道、住宅、歌剧院、酒店/俱乐部、银行、地下室、停车场、农场、天桥/人行道、收费站、加油站、工厂/车间、购物中心/餐厅、图书馆、计算机室，等等

扣板天花板系统的标准安装图

Standard Installation Details for Panelized Ceiling System

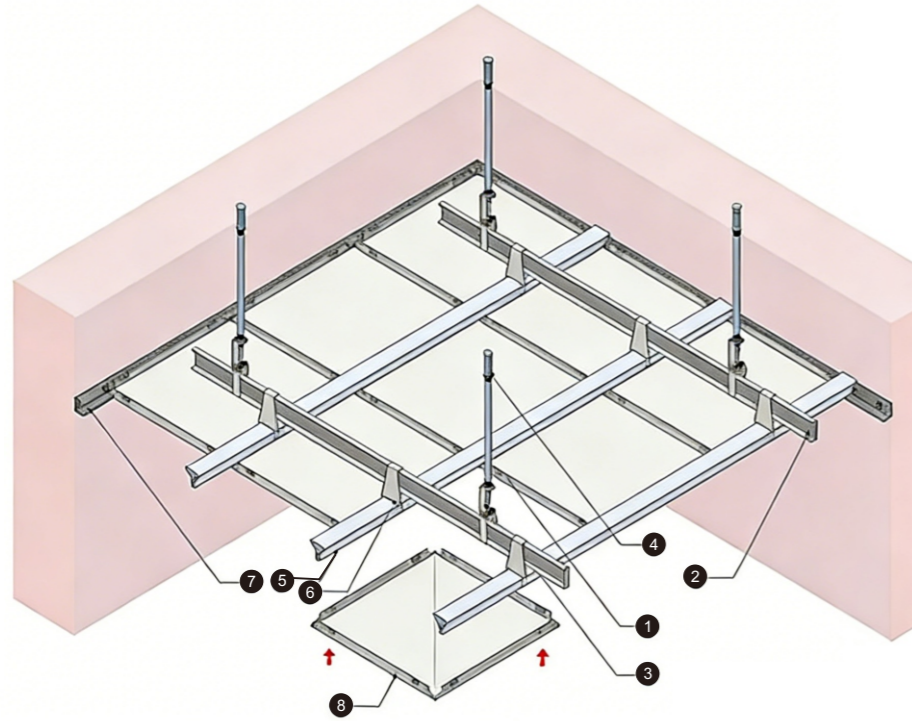

- ① Hanging pole
- ② 38 main keel
- ③ Hanging part of 38 main keel
- ④ Explosive bolt
- ⑤ Triangle keel
- ⑥ Hanging part of triangle keel
- ⑦ Wall angle
- ⑧ Square plate

System Accessories / 系统配件

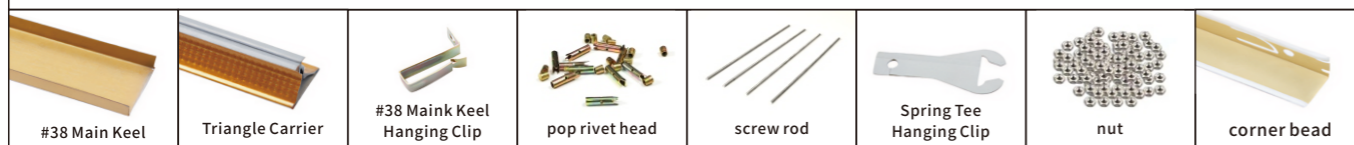

Structural Drawing of Clip-in Ceiling Panel Material

扣板材料结构图

Powder Coating Process

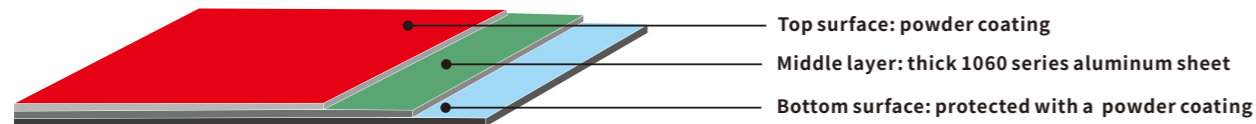

PET Film Process

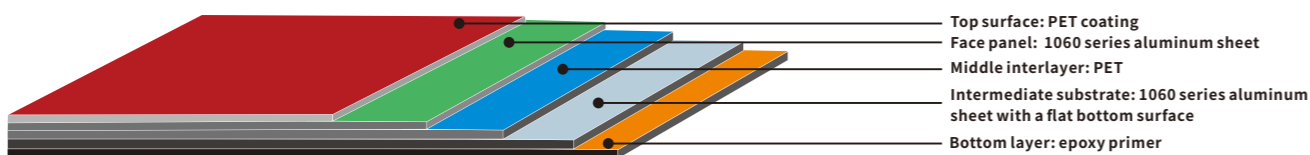

Product Scene Display Image

产品场景展示图

