



Aluminum Square Ceiling Series
铝方通系列

Aluminum U-strip Baffle Ceiling

铝制U型条挡板吊顶

U-Shaped Aluminum Strip Baffle Ceiling System Fireproof/Modern/
Lightweight Pop Ceiling Design



Aluminum baffle ceiling Parameter Chart

Aluminum baffle ceiling Bottom Width	20–200 mm customize
Aluminum baffle ceiling Height	25–200 mm customize
Aluminum baffle ceiling Thickness	0.4–2.0 mm customize
Aluminum baffle ceiling Length	3m or 6m in general; customized lengths are supported

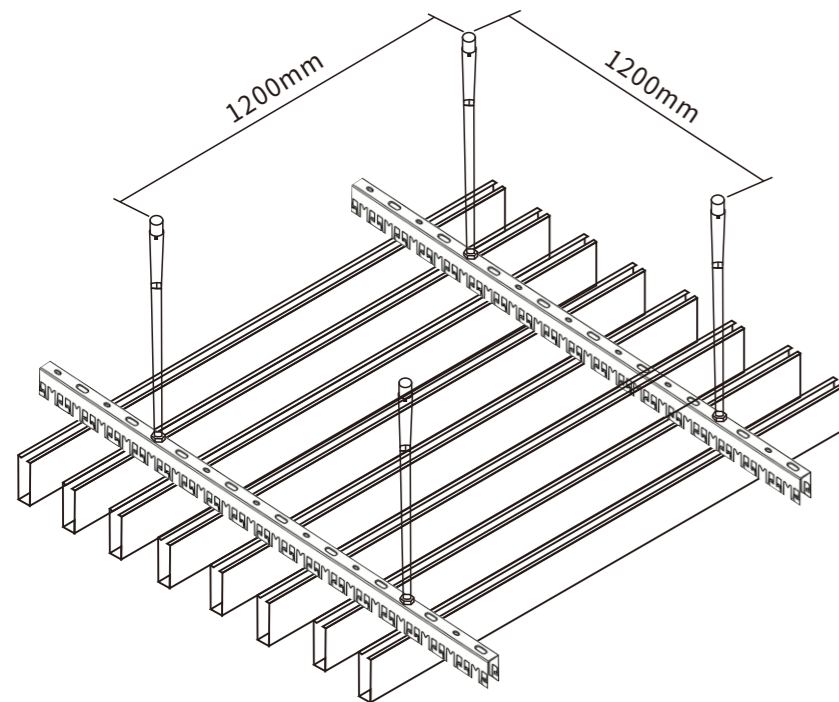

(INSTALLATION DIAGRAM)
安装示意图

System Accessories / 系统配件

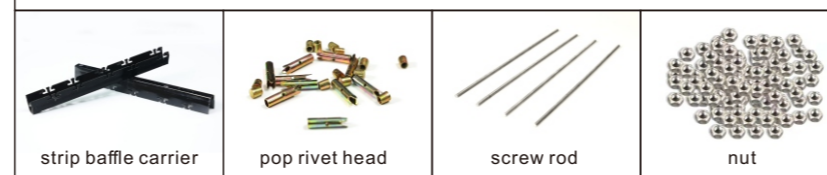

- (A) M8镀锌吊杆
- (C) 型材方通龙骨
- (F) 型材方通天花
- (A) M8 galvanised spreader bars
- (C) Profile square keel
- (F) Profile square ceiling

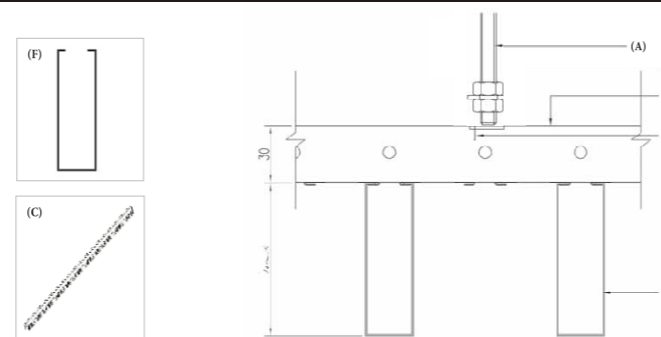

Section Drawing / 正面节点图





Standard Installation of U-shaped Strip Baffle Ceiling System

U型条形挡板天花板系统的标准安装图

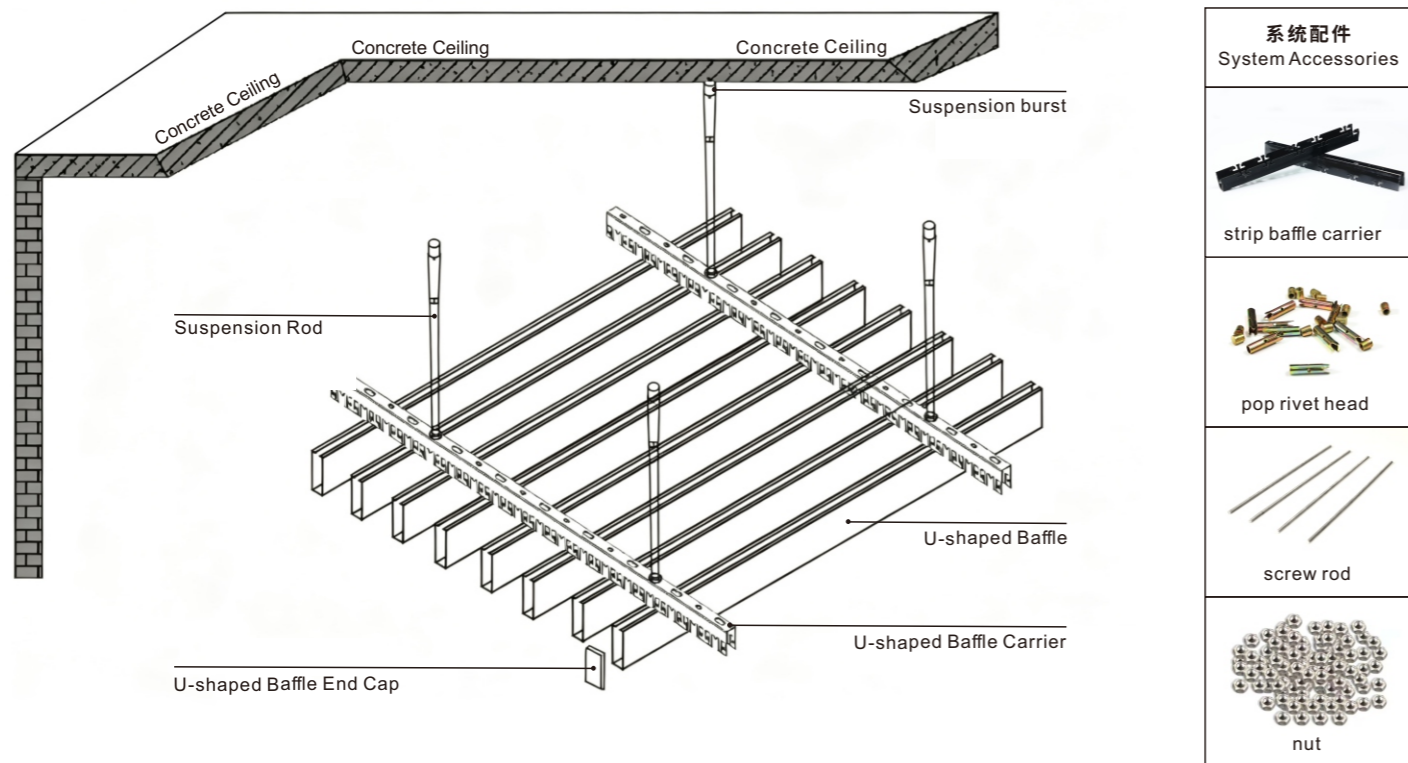

Material Structure Drawing of Square Tube

方通材料结构图

Laminating process

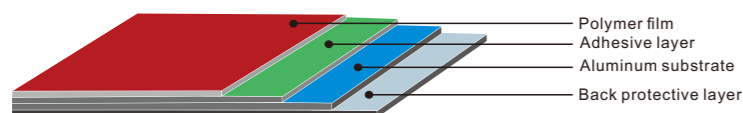

Coating process

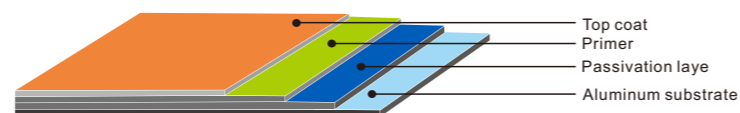

Product Display Image

产品展示图

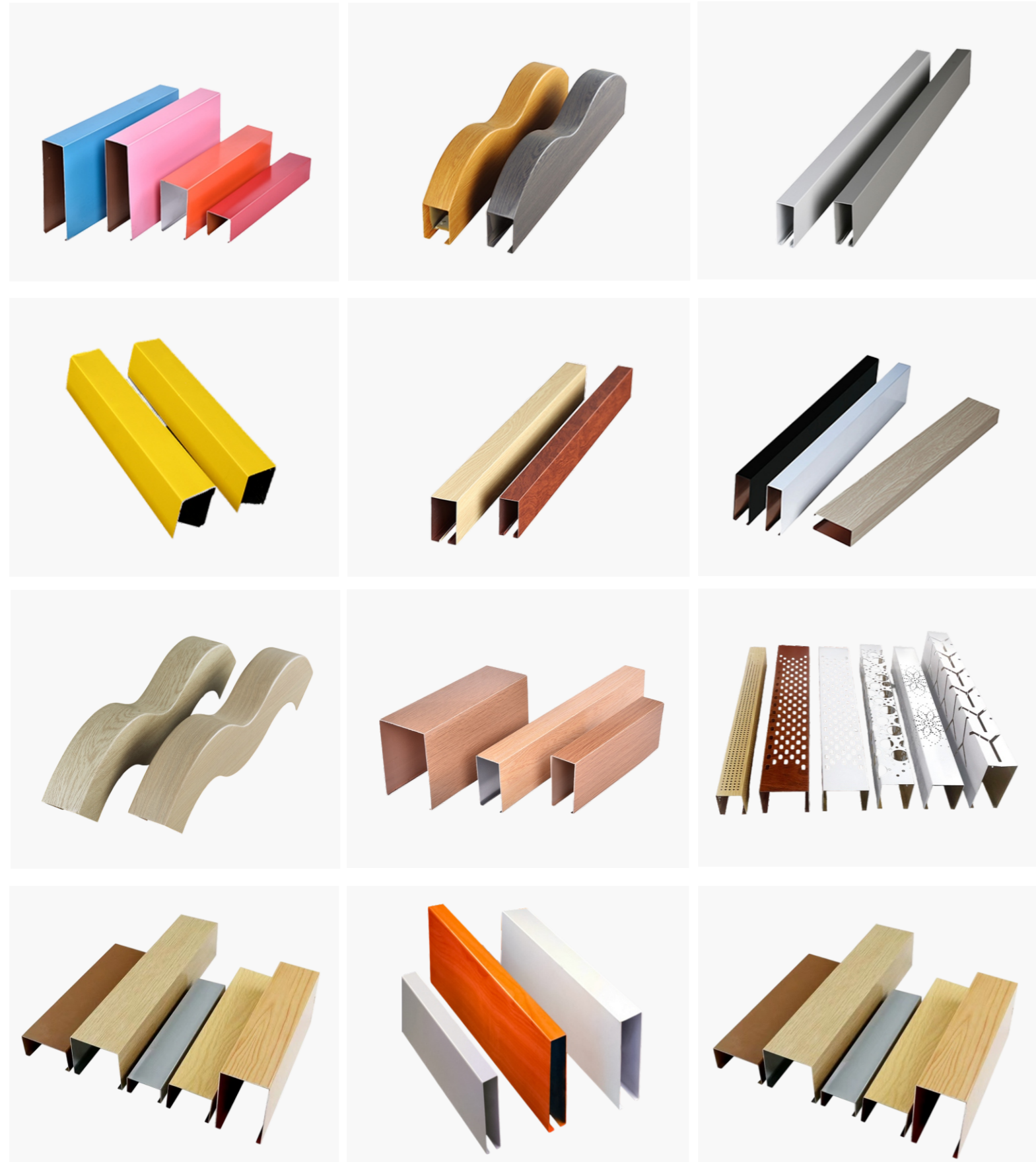

A FULL RANGE OF COLORS MIX AND MATCH FREELY

